

—
THE BOSE®
—

LIFESTYLE® 11
—

MUSIC SYSTEM
—

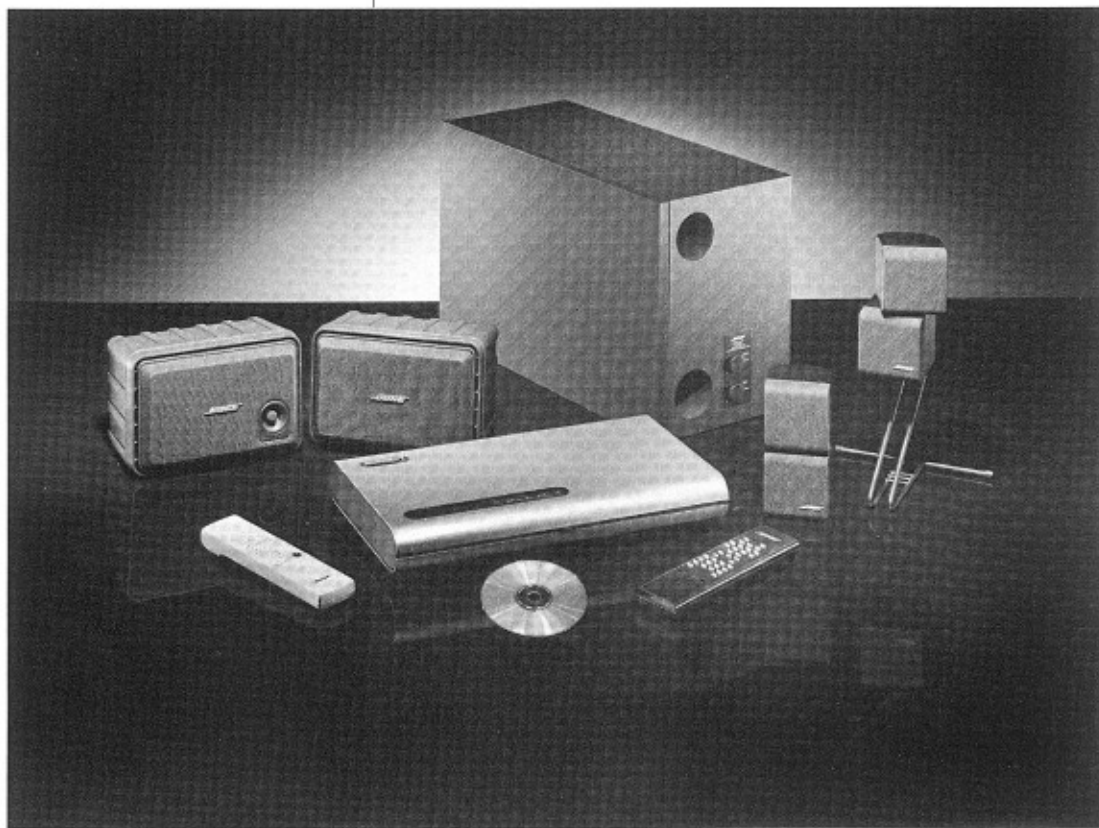

—
OVERVIEW
—

BOSE®

Safety Information

WARNING

To reduce the risk of fire or electric shock, do not expose this system to rain or moisture.

CAUTION

Do not remove the covers of your Lifestyle® music center or powered speaker systems. There are no user-serviceable parts inside. Refer servicing to authorized service personnel.

The CAUTION marks shown on this page are located on your Lifestyle® music system.



The lightning flash with arrowhead symbol, within an equilateral triangle, is intended to alert the user to the presence of uninsulated dangerous voltage within the system enclosure that may be of sufficient magnitude to constitute a risk of electric shock.

The exclamation point within an equilateral triangle, as marked on the system, is intended to alert the user to the presence of important operating and maintenance instructions in this owner's guide.

CAUTION

RISK OF ELECTRICAL SHOCK — DO NOT OPEN.

TO PREVENT ELECTRICAL SHOCK, DO NOT REMOVE COVER. NO USER-SERVICEABLE PARTS INSIDE. REFER SERVICING TO QUALIFIED PERSONNEL.

TO PREVENT FIRE OR SHOCK HAZARD, DO NOT EXPOSE THIS UNIT TO RAIN OR MOISTURE.

AVIS

RISQUE DE CHOC ÉLECTRIQUE — NE PAS OUVRIR.

AFIN DE PRÉVENIR UN CHOC ÉLECTRIQUE NE PAS ENLEVER LE COUVERCLE ARRIÈRE. IL NE SE TROUVE À L'INTÉRIEUR AUCUNE PIÈCE POUVANT ÊTRE RÉPARÉE PAR L'USAGER. S'ADRESSER À UN RÉPARATEUR COMPÉTENT.

CAUTION: TO PREVENT ELECTRIC SHOCK, MATCH WIDE BLADE OF PLUG ON POWER PACK TO WIDE SLOT, FULLY INSERT.

ATTENTION: POUR ÉVITER LES CHOCS ÉLECTRIQUES, INTRODUIRE LA LAME LA PLUS LARGE DE LA FICHE DANS LA BORNE CORRESPONDANTE DE LA PRISE ET POUSSER JUSQU'AU FOND.

OTHER IMPORTANT SAFETY INFORMATION

Refer to the product-specific safety information in each of the enclosed owner's guides.

Contents

Safety Information	2
Getting Started	3
Before you begin	3
Unpacking your system	3
Lifestyle® music system placement considerations	3
Connecting the Acoustimass®-5 speaker system	3
Connecting the Lifestyle® music center antennas	4
Setting up the remote controls	4
Connecting other components	4
Setting up the second listening area	5
Using two listening areas	5
Basic Operation	6
The music center display	6
The music center controls	6
Operating remote controls	6
The RC-11 (black) remote control	6
The RC-5 (white) remote control	7
Listening to the radio	7
Listening to a CD	7
Programming the CD player	7
Advanced Features	8
Getting better sound	8
Changing house codes	8
Maintaining your Lifestyle® music system	8
Customer Service	8

Getting Started

Before you begin ...

Thank you for purchasing a Bose® Lifestyle® 11 music system. We are confident that its fine sound quality will provide you with considerable listening enjoyment.

Please take the time to read this overview carefully. It will help you set up and operate your Lifestyle® music system properly. Use the individual component owner's guides to learn about the advanced features that are built into your system.

Unpacking your system

If you haven't unpacked the Lifestyle® music system, carefully do so now. Save all packing material for possible future use. If any parts appear damaged, do not attempt to use the music system. Instead, repack the carton and notify your authorized Bose® dealer immediately.

The Lifestyle® music system cartons contain (see Figure 1):

Music center

- Lifestyle® music center
- FM dipole antenna
- AM loop antenna
- RC-11 remote control (black)
- 3 AA batteries

Powered Acoustimass®-5 speaker system

- Acoustimass® bass module (larger unit)
- 2 cube speaker arrays
- Audio input cable
- 2 speaker cords

Lifestyle® powered speakers

- LEFT (powered) speaker/power cord/audio input cable
- RIGHT (accessory) speaker/speaker terminals
- Speaker cord with two (2) conductors
- 50-foot (15 m) extension cable

RC-5 remote control

- RC-5 remote control (white)
- 3 AA batteries

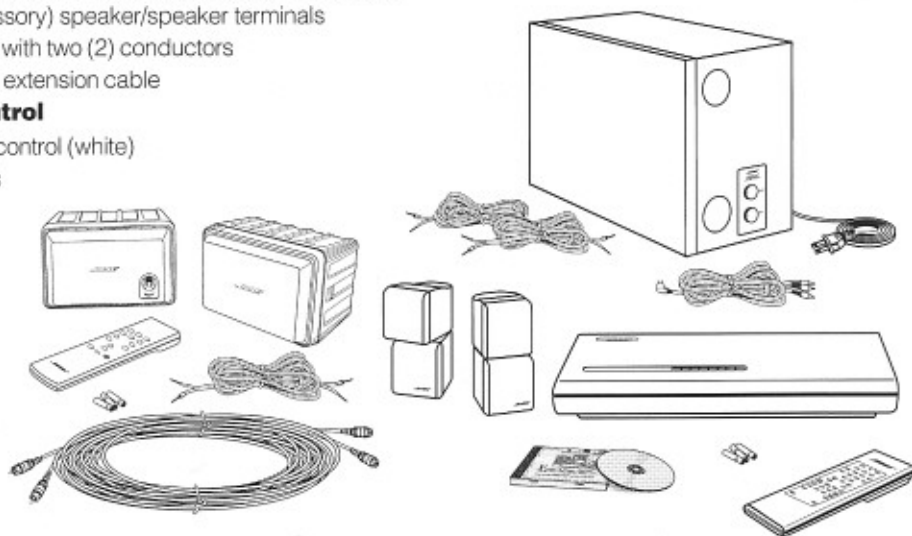

Figure 1

What your music system cartons contain (plus two antennas).

Lifestyle® music system placement considerations

Your Lifestyle® music center's flexibility and small size make it easy to place in a convenient location. For detailed discussion of placement considerations, see *the Lifestyle® music center, powered Acoustimass®-5 series II speaker system, and Lifestyle® powered speaker system owner's manuals.*

Connecting the powered Acoustimass®-5 speaker system

Setting up the cube speakers

Place one cube speaker array on the left side of the room and the other on the right side. In average-sized rooms, you will hear the best stereo sound with the cube arrays 6 to 12 feet (approximately 2 to 4 m) apart. However, you can get excellent sound with the arrays as close as 3 feet (1 m) or as far apart as 15 feet (5 m). The speaker cords provided are long enough to extend 20 feet (6 m) from the bass module.

Setting up the Acoustimass® bass module

With very few exceptions, you can place the module wherever it is most convenient – in a corner, under a table, or even behind a sofa. However, do not cover the two round openings on one end – leave at least 2 inches (5 cm) of space in front of them. Also, do not block the built-in amplifier mounted on the rear of the bass module. The amplifier needs open air to keep heat from building up. As a general rule, you should place the bass module at the same end of the room as the cube arrays.

The bass module ordinarily will produce the most bass when it is placed in the corner of a room. We recommend that you place the module along a wall, 3 to 5 feet (1 to 1.5 m) from a corner.

Connecting the cube speaker arrays to the bass module

CAUTION: Make sure all components (Lifestyle® music center and the Acoustimass® bass module) are unplugged from the power outlet before you begin hooking up the system.

Note that each supplied speaker cord has two wires. The wire marked with a stripe or a red collar is always positive (+) and the plain one is always negative (-). These wires correspond to the positive (red) and negative (black) terminals on the back of each speaker and on the Acoustimass® bass module.

1. Connect the end of one speaker cord to the terminals on the rear of the left cube speaker array. Connect the other end of the cord to the OUTPUT terminals on the rear of the Acoustimass® bass module marked TO LEFT CUBE ARRAY.

To make the connection, push each terminal tab down, then insert the end of the appropriate wire into the exposed hole. Release the tab to secure the wire.

2. Repeat step one for the right cube array. Connect it to the OUTPUT terminal on the Acoustimass® bass module marked TO RIGHT CUBE ARRAY.
3. Check all connections to ensure they are positive to positive (+ to +) and negative to negative (- to -). Check that no strands of wire from any terminal touch any other terminal.

Connecting the bass module to the Lifestyle® music center

Insert the three connectors at one end of the audio input cable into the jacks on the rear panel of the music center as follows:

- Black connector plug into SERIAL DATA OUTPUT jack
- Red connector plug into the R ZONE 1 OUTPUT jack
- White connector plug into the L ZONE 1 OUTPUT jack

See Figure 2 for an illustration of a completed speaker system hookup.

IMPORTANT: If you have a dual voltage music center, make sure to set the voltage selector switch correctly. See the Lifestyle® music center owner's manual for more information.

Plug in the bass module power cord. On models equipped with a POWER switch, turn this switch ON (I).

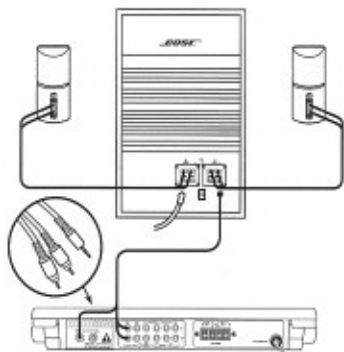

Figure 2

Complete Acoustimass®-5 Series II speaker system hookup.

Connecting the Lifestyle® music center antennas

The rear panel of your Lifestyle® music center provides connectors for FM and AM antennas. Before using your AM/FM tuner, see the Lifestyle® music center owner's manual for detailed instructions about setting up and adjusting the antennas.

Setting up the remote controls

Inserting batteries into the remote controls

Before operating your new Lifestyle® system, insert batteries into the remote controls. When a remote begins to lose its operating range or stops operating altogether, replace its batteries.

1. To remove the battery cover, slide it in the direction of the arrow.
2. Insert a new set of batteries into the battery compartment. Align the + symbols on the batteries with the + symbols inside the battery compartment.
3. Slide the battery cover back on. Make sure it clicks into place.

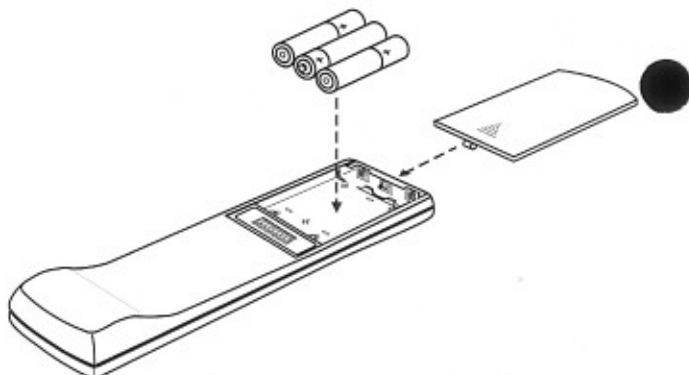

Figure 3

Installing batteries in the remote controls.

Connecting other components

You can connect up to four external components, such as a CD changer, a tape deck, and a TV, VCR, or Laserdisc player to your Lifestyle® music center. Refer to the Using External Components section of the Lifestyle® music center owner's manual.

Setting up the second listening area

Connecting the Lifestyle® powered speaker system to the music center

For complete information on these speakers, consult the *Lifestyle® powered speaker system owner's manual*.

1. If your music system is on, press OFF to shut down. Leave a CD in the CD player to play music in the new listening area.
2. Insert the red plug at the end of the extension cable into the ZONE 2 R (right) OUTPUT jack on the back of the Lifestyle® music center. Insert the black plug into the ZONE 2 OUTPUT jack for the L (left) channel.

Setting up the speakers

1. Take the extension speakers, the white speaker cord, and the white remote control to your second listening area.
2. Place the LEFT and RIGHT speakers (as labeled on the back) on the left and right sides of your room, respectively.

Connecting the speakers to each other

1. Connect the speakers to each other with the white speaker cord, matching the red-ringed wire (+) to the red jack and the other to the black (-) jack. To make the connection, push each terminal tab down, then insert the end of the appropriate wire into the hole. Release the tab to secure the wire.
2. Insert the red and black plugs from the L (left) speaker audio input cable into the corresponding red and black jacks on the free end of the 50-foot (15 m) extension cable.

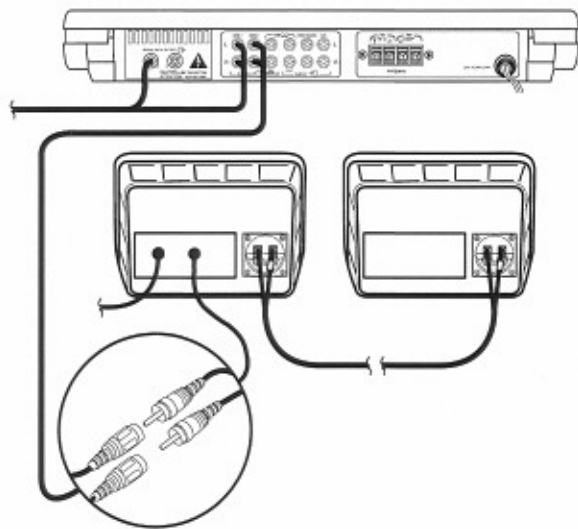

Figure 4

Complete Lifestyle® powered speaker system hookup.

Finishing the speaker setup

1. Turn the volume control on the left speaker counterclockwise to its lowest position.
2. Plug the power cord from the left speaker into a convenient power outlet.
3. Set the volume control to the two o'clock position.

Your Lifestyle® powered speakers are now ready to play. Press the CD button on the white remote control. Enjoy music in your second listening area.

Using two listening areas

Using proprietary electronic circuitry designed by Bose®, the Lifestyle® 11 music system offers you the opportunity to direct sound from one or two sound sources to two different listening areas simultaneously. Each listening area, whether a room or a group of rooms (including outdoor areas), is referred to as a zone. For further discussion of listening areas, see the *Lifestyle® music center owner's manual*.

How zones work

- The signals to the two zones are separate outputs from the music center.
- Any available sound source can be directed to either zone.
- Zones 1 and 2 can each play a different sound source at the same time.
- Only one CD or one radio station can be played at a time.

Zone displays

- When zone 1 is in use, the music center display shows zone 1 information.
- If zone 2 is selected, the display shows zone 2 information for 15 seconds, then reverts to the zone 1 display.
- When only zone 2 is in use, the display shows zone 2 information.

Controlling the zones

- The zones are controlled independently by commands from either the music center or the remote control.
- Check the position of the black remote control ZONE switch before you select a sound source or turn off a zone. The white remote is preset to control zone 2.

Control priority

- Both zones can listen to the same source, but the zone that first selects the source controls the source for the current listening session.
- To gain control of the sound source from the other zone, change the zone switch setting on the remote control or the music center to the zone that has control of the sound source.
- To transfer control of the sound source to the other zone, select another source for the original zone or turn it off.

Basic Operation

This section describes the most-used functions and features of your Lifestyle® music system. For more details about these features and a discussion of additional functions, see Advanced Features, and references to the Lifestyle® music center, powered Acoustimass®-5 series II speaker system, Lifestyle® powered speaker system, and Lifestyle® RC-5 remote control owner's manuals.

The music center display

1. Zone indicator.
2. Source indicators (CD/TUNER/VIDEO/TAPE/AUX).
3. CD track and AM/FM preset number display.
4. Radio station band indicator.
5. CD elapsed time and AM/FM station frequency display.
6. Strong FM stereo reception indicator.
7. Auto-off mode indicator.
8. No disc indicator.
9. Disc repeat indicator/track repeat indicator (flashing).
10. CD pause indicator.
11. CD play indicator.

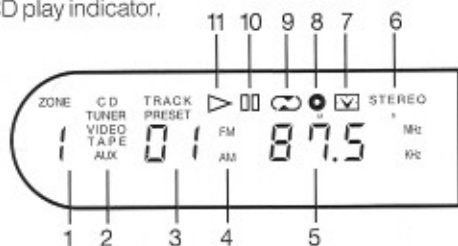
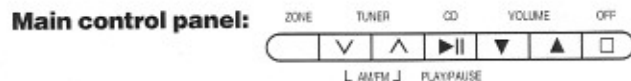

Figure 5

The music center display.

The music center controls



All of these buttons (except OFF) turn the music center on.

ZONE - Selects a zone for music center control and display.

TUNER ∇ / \blacktriangle **AM/FM** - In preset mode, selects the next preset radio station, up or down in sequence. In manual tuning mode, held for a few seconds, seeks up or down to the next strong station. Both keys pressed simultaneously switches between AM and FM.

CD $\blacktriangleright \parallel$ **PLAY/PAUSE** - Selects the built-in CD player and turns the system on if it is off. Begins or pauses play of the currently selected music source. When held down for two seconds, stops play of a CD.

VOLUME ∇ / \blacktriangle - Lower or raise the volume in the selected zone.

OFF - Turns the entire system off.

CD cover latch - Opens the CD cover for loading or removing a CD, and access to the inside control panel.

Inside control panel:



MANUAL - Selects between PRESET and MANUAL tuning modes.

MEMORY (PRESET) - Selects a preset location.

STORE (PRESET) - Stores an AM or FM station in a preset location.

TAPE/AUX/VIDEO - Select each of three external component sources for listening in either or both zones.

AUTO-OFF - In zone 1, initiates a 75-minute countdown before the system shuts off. Each additional key press reduces shutoff time by 15 minutes. AUTO-OFF may be set independently for zone 2 for a fixed 60-minute delay.

Operating the remote controls

The advanced radio-frequency remote controls work from anywhere in your home. You do not need to aim the remotes at the music center.

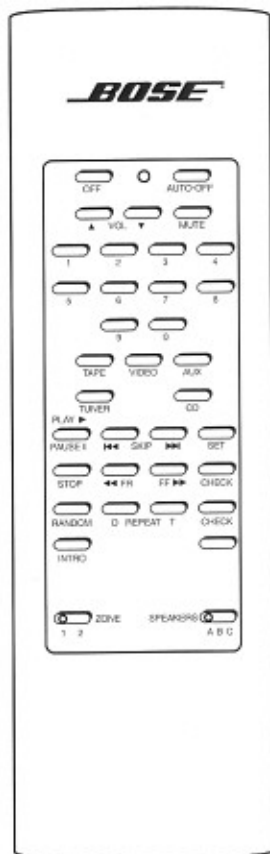

The RC-11 remote control (black)

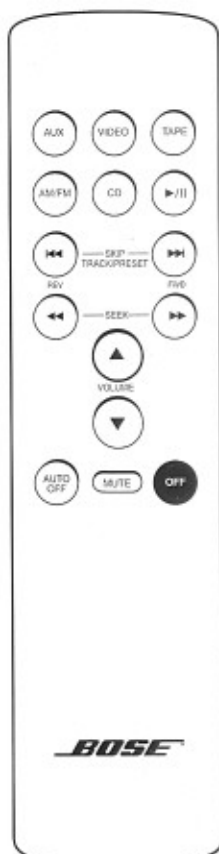

The RC-5 remote control (white)

Figure 6

The Lifestyle® remote controls.

The RC-11 (black) remote control

OFF - Turns off the selected zone.

LED - Lights to show a remote control key has been pressed.

AUTO OFF - Initiates a timed countdown before the system shuts off.

VOL ▲ / ▼ - Raise or lower the volume.

MUTE - Silences speakers in the selected zone. Press again to restore the previous volume.

0 - 9 (number keys) - Provide direct access to preset radio stations and CD tracks.

TAPE / VIDEO / AUX - Select externally connected tape deck; TV, VCR, or Laserdisc; or CD changer or other component and turn the system on if it is off.

TUNER - Selects the built-in radio and turns the system on if it is off. If the radio is on, selects the next preset.

CD - Selects the built-in CD player and turns the system on if it is off.

PLAY ► / PAUSE II - Begins or pauses play of the currently selected music source.

STOP - Stops play of a CD.

RANDOM - Plays CD tracks in random order.

INTRO - Plays the first 10 seconds of each CD track.

◀◀ / ▶▶ **SKIP** - Select the previous or next CD track.

◀◀ **FR** / ▶▶ **FF (search/seek)** - Search back or forward through a CD.

D (disc) / T (track) REPEAT - Replay the disc or track that just played.

SET (programming key) - Selects the current CD track for a programmed play sequence.

CHECK (programming key) - Press this key repeatedly to display the programmed play sequence one track at a time.

CLEAR (programming key) - Use this key with the CHECK key to clear the displayed CD track from the programmed play sequence.

Blank key (disc key) - With an attached CD changer and the Bose® CE-1 Control Expander™ unit, this key selects the next disc or gives direct CD access.

ZONE 1 - 2 switch - Selects which zone the RC-11 controls.

SPEAKERS A-B-C switch - For future use.

The RC-5 (white) remote control

TAPE / VIDEO / AUX - Select externally connected tape deck; TV, VCR, or Laserdisc; or CD changer or other component and turn the system on if it is off.

AM/FM - Selects the built-in radio and turns the system on if it is off. When radio is on, selects the next preset.

CD - Selects the built-in CD player and turns the system on if it is off.

► / II **(play/pause)** - Begins or pauses play of the currently selected music source.

◀◀ / ▶▶ **SKIP** - Select the previous or next CD track.

◀◀ / ▶▶ **SEEK** - Search backward or forward through a CD.

VOLUME ▲ / ▼ - Raise or lower the volume.

AUTO OFF - Initiates a timed countdown before the system shuts off.

MUTE - Silences your speakers. Also restores volume to muted speakers.

OFF - Turns zone 2 off.

Listening to the radio

Turning the radio on and off

- Press TUNER or AM/FM on a remote or TUNER ▼ or ▲ on the control panel to turn your music system on to the most recently heard radio station.
- Press the OFF key on the remote or on the console.

Programming the tuner

1. To preset radio stations, open the music center cover to access the inside control panel. (Have paper and pencil ready to record the station settings.)
2. Follow the five-step instructions located above the inside control panel.
3. Set up to 30 AM and FM stations. Switch between AM and FM by pressing TUNER ▼ or ▲ simultaneously.

Selecting a preset station

- Press the control panel TUNER ▼ or ▲ key to select the next or the previous preset station.
- Press the black remote TUNER key or the white remote AM/FM key to select the next preset station.
- Press the number key(s) for the preset station you want, followed by the TUNER key, to directly select that station.

Manual tuning

1. Open the music center cover.
2. Press the MANUAL key.
3. Press TUNER ▼ or ▲ to move to a lower or higher station frequency, as desired.
4. Push the music center cover down until the latch clicks.

Listening to a CD

Loading a CD into the music center

Open the music center cover, and place a CD, label side up, onto the spindle. Close the cover.

Turning the system on and choosing the CD player

Press the CD key on either remote or the CD key on the music center. The CD indicator will light. If a CD has been loaded, it will begin to play.

Using the music center CD player

- To play a stopped or paused CD, press ►/ || (PLAY/PAUSE) on the remote control or the music center.
- To pause a CD, press ►/ || (PLAY/PAUSE).
- To stop a CD, press STOP on the black remote, or open the music center cover.

Programming the CD player

Use the RC-11 (black) remote control to program the music center CD player to play tracks in any order you choose. For instructions on how to program your CD player, see *the Lifestyle® music center owner's manual*.

Advanced Features

Please familiarize yourself with the Basic Operation section before exploring more advanced features, described in detail in *the Lifestyle® music center and Lifestyle® RC-5 remote control owner's manuals*.

Getting better sound

After you have listened to your Lifestyle® music system, you may wish to adjust the sound to your taste. There are two ways to do this: use the room compensation controls located on the Acoustimass® bass module or change the position of the system components. Review placement suggestions in *the Lifestyle® music center, powered Acoustimass® -5 series II speaker system, and Lifestyle® powered speaker system owner's manuals*. Also see the section on room compensation controls in *the powered Acoustimass® -5 series II speaker system owner's manual*.

Changing house codes

If your Lifestyle® remote control commands conflict with those of another nearby Lifestyle® music system, set a new house code for your system and its remote controls. Follow the procedures discussed in The Remote Control section of *the Lifestyle® music center owner's manual* and in the Introduction section of *the Lifestyle® RC-5 remote control owner's manual*.

Maintaining your music system

For information on taking care of your music system, see references to cleaning each of the components in the respective owner's manuals. For information on replacing batteries in the remote controls, see page 4 of this *overview*, or *the Lifestyle® music center and Lifestyle® RC-5 remote control owner's manuals*.

Customer service

Your Lifestyle® 11 music system is covered by a one year limited warranty. For questions or help with your Lifestyle® 11 music system, call **1-800-288-BOSE (2673)**. Outside the USA and Canada, call 508-879-7330, extension 3990.

BOSE®
Better sound through research®